

# Energieverbund Stein Meiringen (EVS)

## Richtpreise Wärmepumpensysteme F 1145 mit Wassererwärmer und Heizungsspeicher

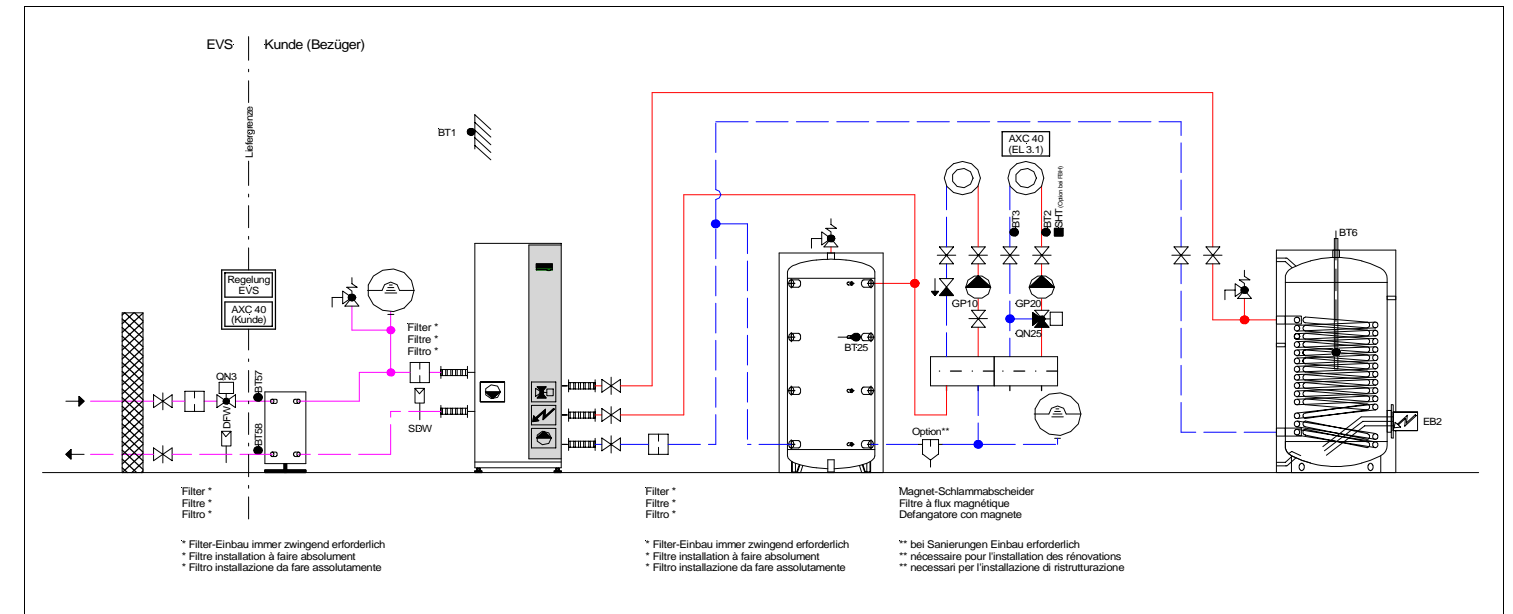
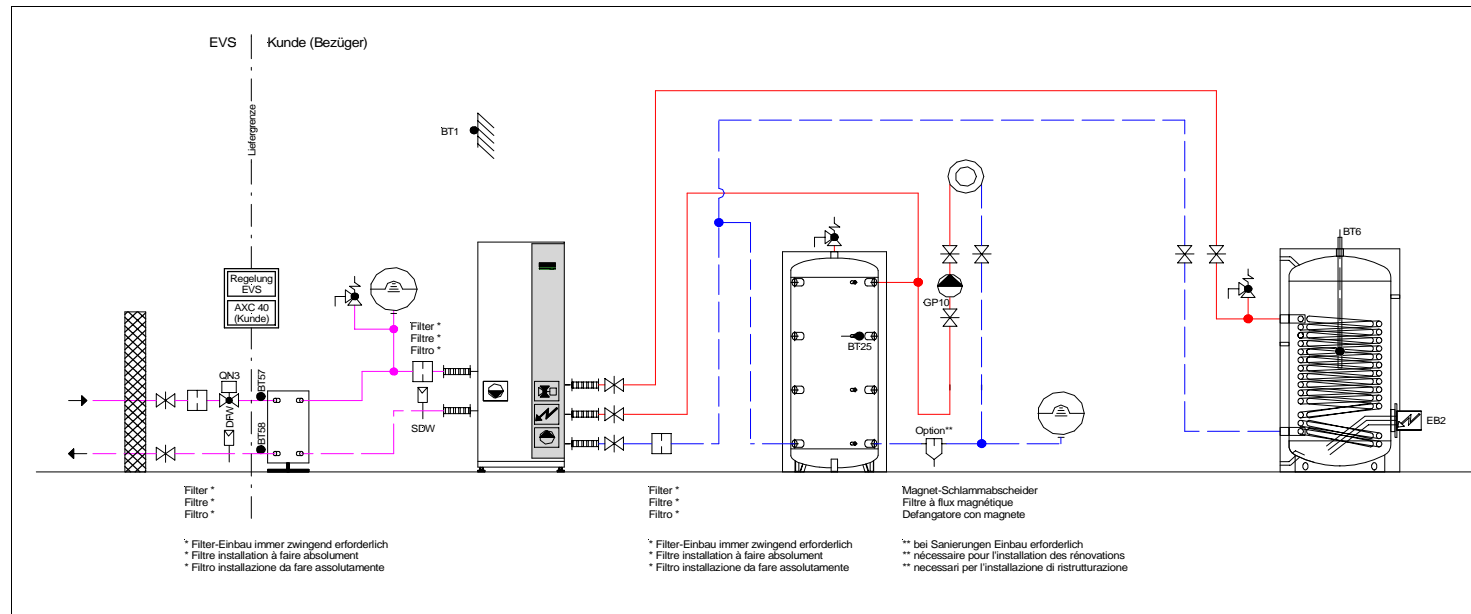

LIEBI WPSYSTEMMODUL EFFIZIENTE WÄRMEPUMPEN MIT SYSTEM	Wärmepumpe	Speicher			Wassererwärmer			Richtpreis (exkl. MWST)
		LHS-301	LHS-501	LHS-801	LWE-401HR	LWE-501HR	LWE-601HR	
F 1145-8_6.202	F 1145 - 8	●			●			CHF 19'490.00
F 1145-8_6.203	F 1145 - 8	●				●		CHF 19'885.00
F 1145-8_6.203	F 1145 - 8		●			●		CHF 20'214.00
F 1145-8_6.204	F 1145 - 8		●				●	CHF 20'834.00
F 1145-8_6.203	F 1145 - 8			(●)		●		CHF 20'464.00
F 1145-8_6.204	F 1145 - 8			(●)			●	CHF 21'084.00
<hr/>								
F 1145-10_6.202	F 1145 - 10	●			●			CHF 20'140.00
F 1145-10_6.203	F 1145 - 10	●				●		CHF 20'535.00
F 1145-10_6.203	F 1145 - 10		●			●		CHF 20'864.00
F 1145-10_6.204	F 1145 - 10		●				●	CHF 21'484.00
F 1145-10_6.203	F 1145 - 10			●		●		CHF 21'114.00
F 1145-10_6.204	F 1145 - 10			●			●	CHF 21'734.00
<hr/>								
F 1145-12_6.202	F 1145 - 12	●			●			CHF 20'901.00
F 1145-12_6.203	F 1145 - 12	●				●		CHF 21'296.00
F 1145-12_6.203	F 1145 - 12		●			●		CHF 21'625.00
F 1145-12_6.204	F 1145 - 12		●				●	CHF 22'245.00
F 1145-12_6.203	F 1145 - 12			●		●		CHF 21'875.00
F 1145-12_6.204	F 1145 - 12			●			●	CHF 22'495.00

(●) nur in Verbindung mit PV möglich

LIEBI WPSYSTEMMODUL EFFIZIENTE WÄRMEPUMPEN MIT SYSTEM	Wärmepumpe	Speicher			Wassererwärmer			Richtpreis (exkl. MWST)
		LHS-301	LHS-501	LHS-801	LWE-401HR	LWE-501HR	LWE-601HR	
F 1145-8_6.212	F 1145 - 8	●			●			CHF 21'242.00
F 1145-8_6.213	F 1145 - 8	●				●		CHF 21'637.00
F 1145-8_6.213	F 1145 - 8		●			●		CHF 21'966.00
F 1145-8_6.214	F 1145 - 8		●				●	CHF 22'586.00
F 1145-8_6.213	F 1145 - 8			(●)		●		CHF 22'216.00
F 1145-8_6.214	F 1145 - 8			(●)			●	CHF 22'836.00
<hr/>								
F 1145-10_6.212	F 1145 - 10	●			●			CHF 21'892.00
F 1145-10_6.213	F 1145 - 10	●				●		CHF 22'287.00
F 1145-10_6.213	F 1145 - 10		●			●		CHF 22'616.00
F 1145-10_6.214	F 1145 - 10		●				●	CHF 23'236.00
F 1145-10_6.213	F 1145 - 10			(●)		●		CHF 22'866.00
F 1145-10_6.214	F 1145 - 10			(●)			●	CHF 23'486.00
<hr/>								
F 1145-12_6.212	F 1145 - 12	●			●			CHF 22'653.00
F 1145-12_6.213	F 1145 - 12	●				●		CHF 23'048.00
F 1145-12_6.213	F 1145 - 12		●			●		CHF 23'377.00
F 1145-12_6.214	F 1145 - 12		●				●	CHF 23'997.00
F 1145-12_6.213	F 1145 - 12			(●)		●		CHF 23'627.00
F 1145-12_6.214	F 1145 - 12			(●)			●	CHF 24'247.00

(●) nur in Verbindung mit PV möglich

# Energieverbund Stein Meiringen (EVS)

## Richtpreise Wärmepumpensysteme F 1145 / S 1155 mit Kombispeicher

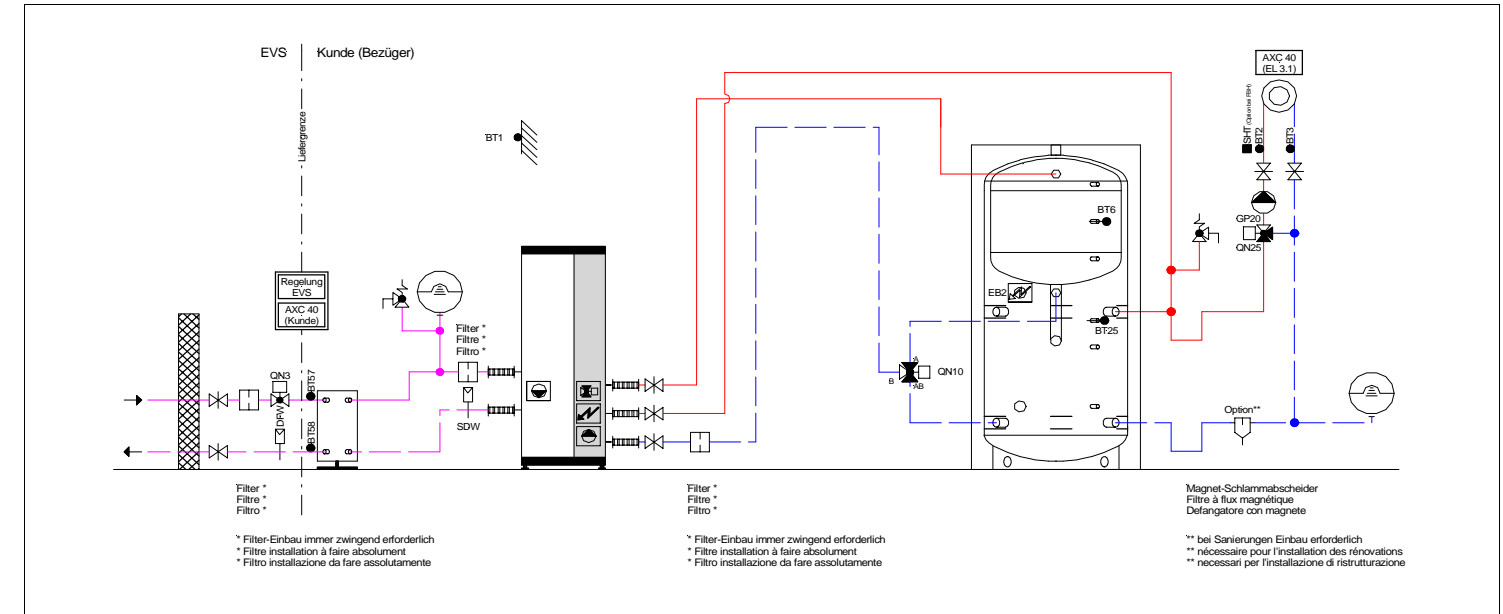
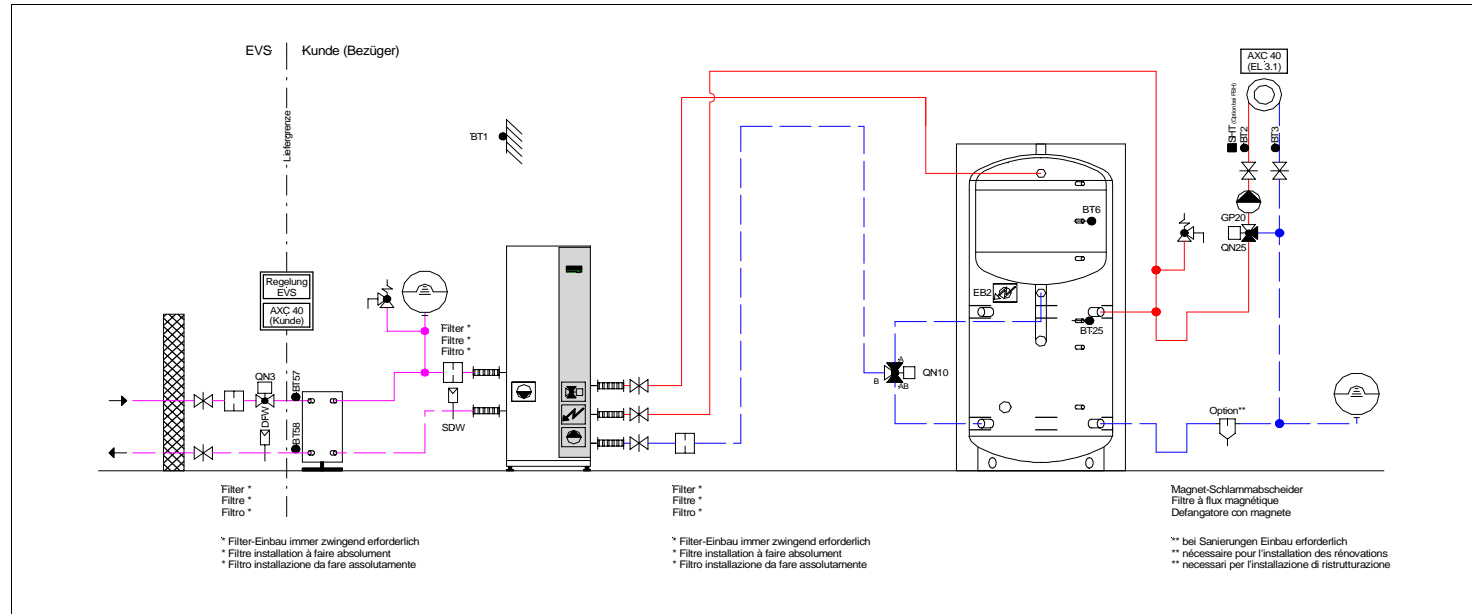

LIEBI	Wärmepumpe	Kombispeicher				Richtpreis (exkl. MWST)
		WP 650 / 180	WP 750 / 220	WP 850 / 260	WP 950 / 320	
F 1145-8_8.1.01	F 1145 - 8	•				CHF 22'138.00
F 1145-8_8.1.02	F 1145 - 8		•			CHF 22'588.00
F 1145-8_8.1.03	F 1145 - 8			•		CHF 22'858.00
F 1145-8_8.1.04	F 1145 - 8				•	CHF 23'233.00
F 1145-10_8.1.02	F 1145 - 10		•			CHF 23'238.00
F 1145-10_8.1.03	F 1145 - 10			•		CHF 23'508.00
F 1145-10_8.1.04	F 1145 - 10				•	CHF 23'883.00
F 1145-12_8.1.02	F 1145 - 12		•			CHF 23'999.00
F 1145-12_8.1.03	F 1145 - 12			•		CHF 24'269.00
F 1145-12_8.1.04	F 1145 - 12				•	CHF 24'644.00

LIEBI	Wärmepumpe	Kombispeicher				Richtpreis (exkl. MWST)
		WP 650 / 180	WP 750 / 220	WP 850 / 260	WP 950 / 320	
S 1155-12_8.1.02	S 1155 - 12		•			CHF 26'271.00
S 1155-12_8.1.03	S 1155 - 12			•		CHF 26'915.00
S 1155-12_8.1.04	S 1155 - 12				•	CHF 26'916.00

# Energieverbund Stein Meiringen (EVS)

## Richtpreise Wärmepumpensysteme S 1155 mit Wassererwärmer mit/ohne Heizungsspeicher

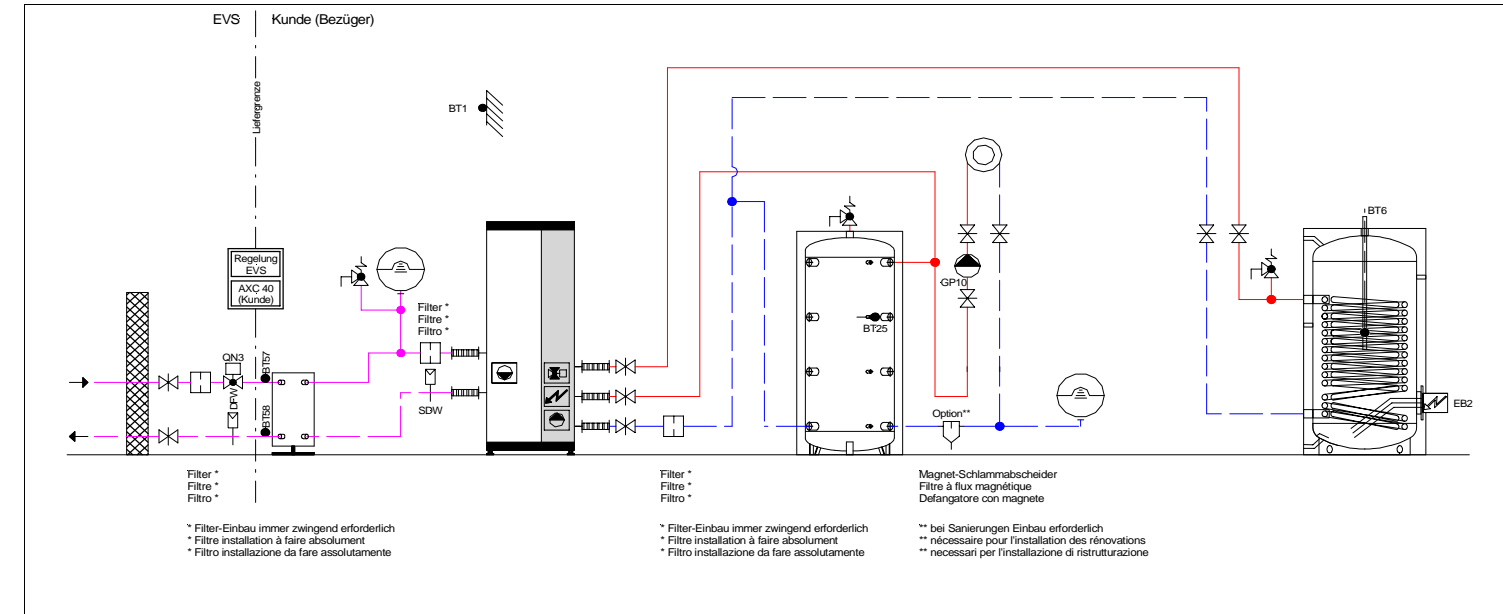
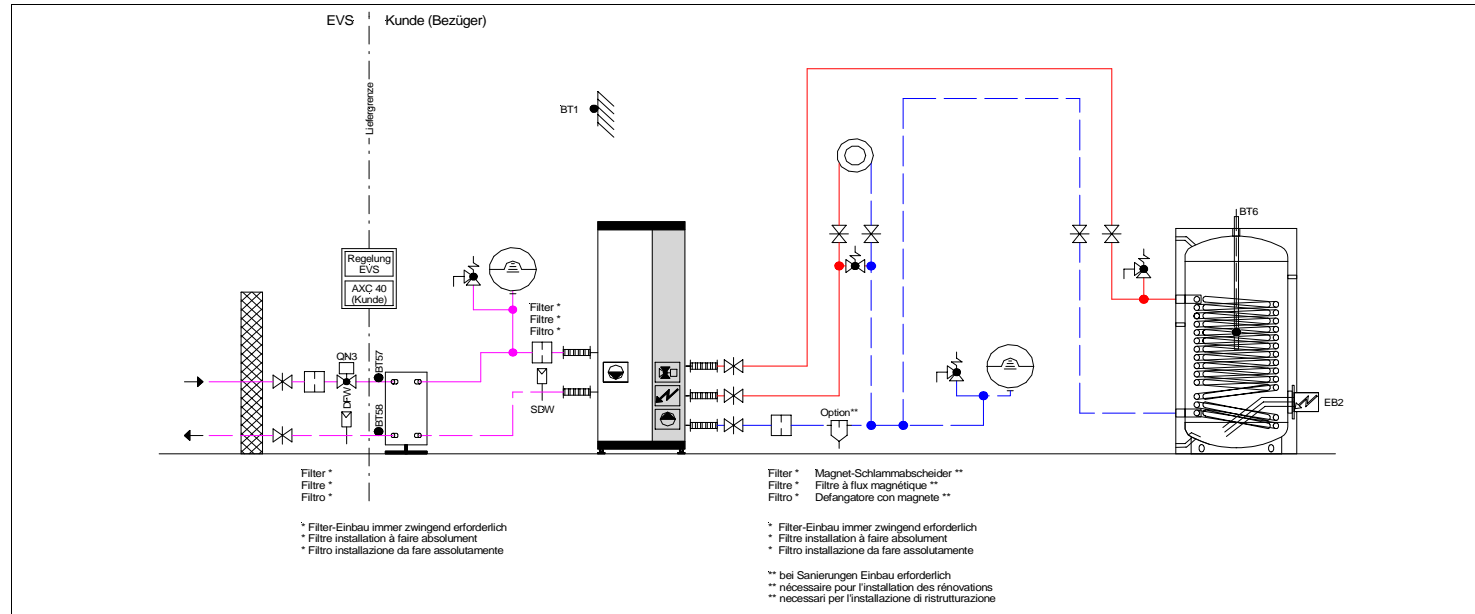

LIEBI WPSYSTEMMODUL EFFIZIENTE WÄRMEPUMPEN MIT SYSTEM	Wärmepumpe	Speicher			Wassererwärmer			Richtpreis (exkl. MWST)
		LHS-301	LHS-501	LHS-801	LWE-401HR	LWE-501HR	LWE-601HR	
S 1155-12_2.202	S 1155 - 12				•			CHF 21'160.00
S 1155-12_2.203	S 1155 - 12					•		CHF 21'555.00
S 1155-12_2.204	S 1155 - 12						•	CHF 22'175.00

LIEBI WPSYSTEMMODUL EFFIZIENTE WÄRMEPUMPEN MIT SYSTEM	Wärmepumpe	Speicher			Wassererwärmer			Richtpreis (exkl. MWST)
		LHS-301	LHS-501	LHS-801	LWE-401HR	LWE-501HR	LWE-601HR	
S 1155-12_6.202	S 1155 - 12	•			•			CHF 23'173.00
S 1155-12_6.203	S 1155 - 12	•				•		CHF 23'568.00
S 1155-12_6.203	S 1155 - 12		•			•		CHF 23'897.00
S 1155-12_6.204	S 1155 - 12		•				•	CHF 24'517.00
S 1155-12_6.203	S 1155 - 12			•		•		CHF 24'147.00
S 1155-12_6.204	S 1155 - 12			•		•		CHF 24'767.00

# Energieverbund Stein Meiringen (EVS)

## Richtpreise Wärmepumpensysteme S 1255 mit Intergal-Wassererwärmer mit/ohne Heizungsspeicher

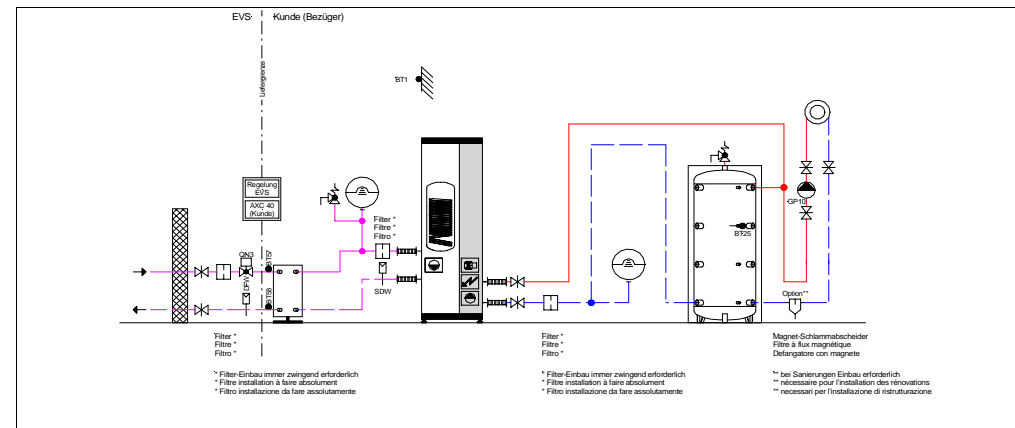
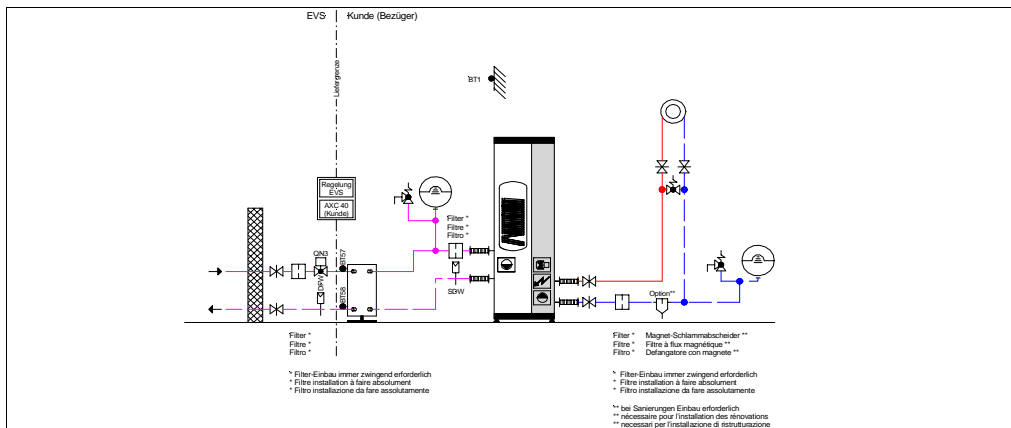

 WPSYSTEMMODUL EFFIZIENTE WÄRMEPUMPEN MIT SYSTEM	Wärmepumpe	Speicher			Wassererwärmer	Richtpreis (exkl. MWST)
		LHS-301	LHS-501	LHS-801	Integral 180 l	
S 1255-12_2.01	S 1255 - 12				●	CHF 19'715.00

 WPSYSTEMMODUL EFFIZIENTE WÄRMEPUMPEN MIT SYSTEM	Wärmepumpe	Speicher			Wassererwärmer	Richtpreis (exkl. MWST)
		LHS-301	LHS-501	LHS-801	Integral 180 l	
S 1255-12_6.01	S 1155 - 12	●			●	CHF 21'728.00
S 1255-12_6.01	S 1155 - 12		●		●	CHF 22'057.00
S 1255-12_6.01	S 1155 - 12			●	●	CHF 22'307.00